



LED High Power Wall Light 3W / 6W - P2

LED High Power Wall Light 9W / 18W - P3

LED High Power Wall Light 3W - P4

LED High Power Staircase Light 3W - P5

LED Strip Light / Linear Light / Digital Tube 12W - P6

LED Strip Light / Linear Light / Digital Tube 12W - P7

LED Coin light / Cluster light / Pixel Light 3W - P8

LED Coin light / Cluster light / Pixel Light 4.5W - P9



LED source	CREE or OSRAM			
LED QTY(PCS)	3Pcs / 6Pcs			
Dimension(mm)	Ø90 x H190 / Ø90 x H240			
LED power(w)	1W			
Rate of power(w)	3w			
Range of voltage(v/Hz)	AC110-240V / DC24V			
Beam Angle	8° / 15° / 25° / 45° / 60°			
Color temperature/K	3000K	4000K	5000K	6500
	√	√	√	√
	2200K	2700K	RGB-FULL	DMX
	√	√	√	√
CRI (Ra>)	Ra≥80			
Lifespan	> 5000h			
Radiator	Die-cast aluminum / Electrostatic spraying			
Net weight(g)	1.1KG / 1.8KG(For LED POWER DRIVER INSIDE)			
Dimmable	DMX			
Working environment	-30~50°C/10% ~ 90% R.H			
Ingress Protection	IP66			



LED source	CREE or OSRAM			
LED QTY(PCS)	9Pcs / 18Pcs			
Dimension(mm)	Ø140 x H190 / Ø140 x H230			
LED power(w)	1W			
Rate of power(w)	9w / 18w			
Range of voltage(v/Hz)	AC110-240V / DC24V			
Beam Angle	8° / 15° / 25° / 45° / 60°			
Color temperature/K	3000K	4000K	5000K	6500
	√	√	√	√
	2200K	2700K	RGB-FULL	DMX
	√	√	√	√
CRI (Ra>)	Ra≥80			
Lifespan	> 5000h			
Radiator	Die-cast aluminum / Electrostatic spraying			
Net weight(g)	2KG / 3KG(For LED POWER DRIVER INSIDE)			
Dimmable	DMX			
Working environment	-30~50°C/10% ~ 90% R.H			
Ingress Protection	IP66			

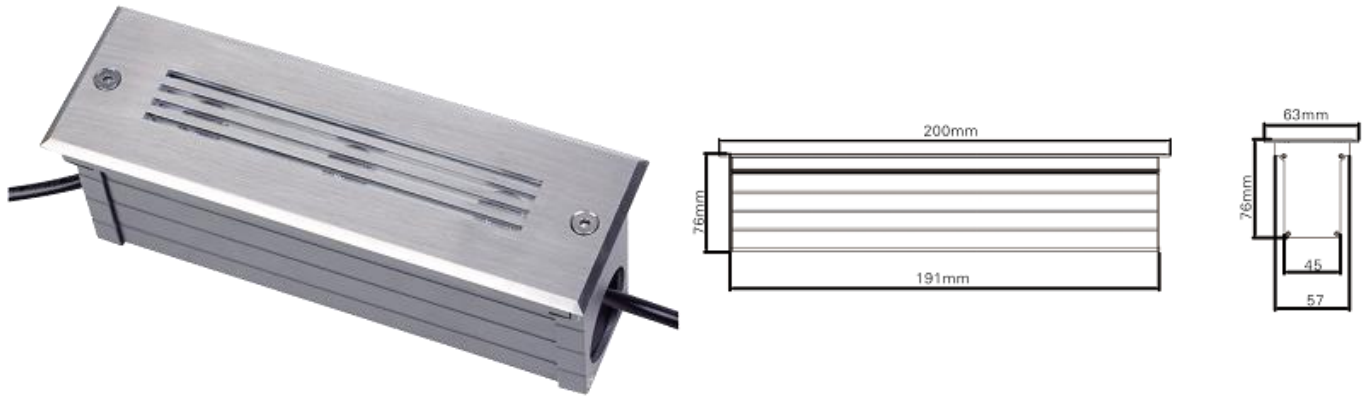

LED source	CREE or OSRAM			
LED QTY(PCS)	3Pcs			
Dimension(mm)	L200 x W63 x H76			
LED power(w)	1W			
Rate of power(w)	3w			
Range of voltage(v/Hz)	AC110-240V / DC24V			
Beam Angle	8° / 15° / 25° / 45° / 60°			
Color temperature/K	3000K	4000K	5000K	6500
	√	√	√	√
	2200K	2700K	RGB-FULL	DMX
	√	√	√	√
CRI (Ra>)	Ra≥80			
Lifespan	> 5000h			
Radiator	Die-cast aluminum / Electrostatic spraying			
Net weight(g)	0.8KG (For LED POWER DRIVER INSIDE)			
Dimmable	DMX			
Working environment	-30~50°C / 10% ~ 90% R.H			
Ingress Protection	IP66			

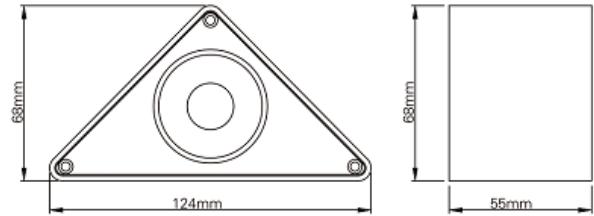

LED source	CREE or OSRAM			
LED QTY(PCS)	1Pcs			
Dimension(mm)	L124 x W68 x H55			
LED power(w)	1W			
Rate of power(w)	3w			
Range of voltage(v/Hz)	DC12V			
Beam Angle	8° / 15° / 25° / 45° / 60°			
Color temperature/K	3000K	4000K	5000K	6500
	√	√	√	√
	2200K	2700K	RGB-FULL	DMX
	√	√	√	√
CRI (Ra>)	Ra≥80			
Lifespan	> 5000h			
Radiator	Die-cast aluminum / Electrostatic spraying			
Net weight(g)	0.3KG			
Dimmable	DMX			
Working environment	-30~50°C/10% ~ 90% R.H			
Ingress Protection	IP66			

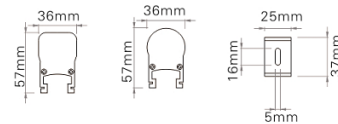

LED source	CREE or OSRAM			
LED QTY(PCS)	48Pcs			
Dimension(mm)	L200 x W36 x H57			
LED power(w)	0.25W			
Rate of power(w)	12w			
Range of voltage(v/Hz)	DC24V			
Beam Angle	120°			
Color temperature/K	3000K	4000K	5000K	6500
	√	√	√	√
	2200K	2700K	RGB-FULL	DMX
	√	√	√	X
CRI (Ra>)	Ra≥80			
Lifespan	> 5000h			
Radiator	Die-cast aluminum / Electrostatic spraying			
Net weight(g)	0.7KG			
Dimmable	Non-dimmable			
Working environment	-30~50°C / 10% ~ 90% R.H			
Ingress Protection	IP65			

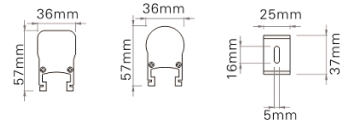

LED source	CREE or OSRAM			
LED QTY(PCS)	48Pcs			
Dimension(mm)	L1000 x W50 x H60 / L1000 x W50 x H76			
LED power(w)	0.25W			
Rate of power(w)	12w			
Range of voltage(v/Hz)	DC24V			
Beam Angle	120°			
Color temperature/K	3000K	4000K	5000K	6500
	√	√	√	√
	2200K	2700K	RGB-FULL	DMX
	√	√	√	X
CRI (Ra>)	Ra≥80			
Lifespan	> 5000h			
Radiator	Die-cast aluminum / Electrostatic spraying			
Net weight(g)	1KG			
Dimmable	Non-dimmable			
Working environment	-30~50°C/10%~90% R.H			
Ingress Protection	IP65			

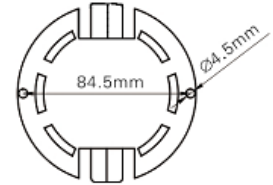
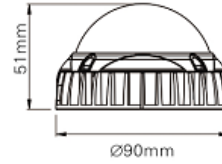

LED source	CREE or OSRAM			
LED QTY(PCS)	12Pcs			
Dimension(mm)	Ø90 x H51			
LED power(w)	0.25W			
Rate of power(w)	3w			
Range of voltage(v/Hz)	DC24V			
Beam Angle	120°			
Color temperature/K	3000K	4000K	5000K	6500
	√	√	√	√
	2200K	2700K	RGB-FULL	DMX
	√	√	√	X
CRI (Ra>)	Ra≥80			
Lifespan	> 5000h			
Radiator	Stretched aluminum housing / Electrostatic spraying			
Net weight(g)	0.24KG			
Dimmable	Non-dimmable			
Working environment	-30~50°C/10% ~ 90% R.H			
Ingress Protection	IP66			

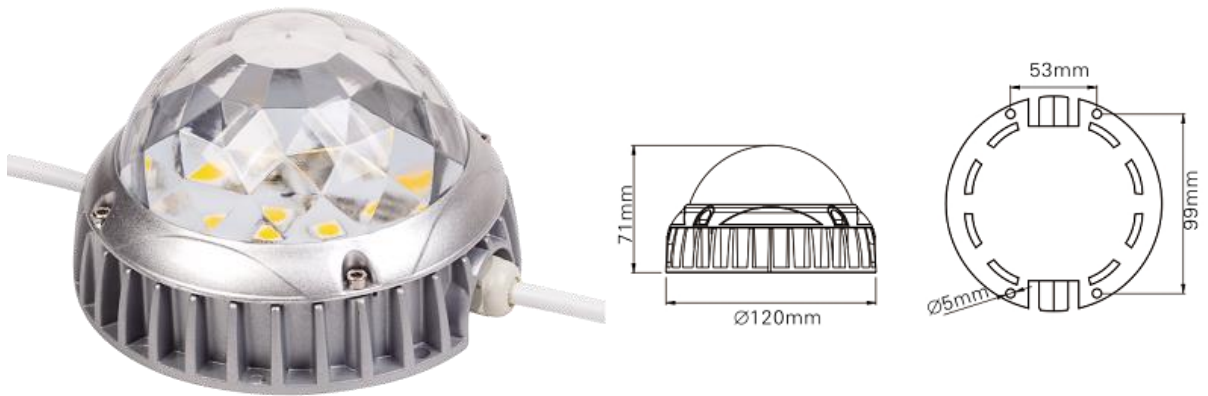

LED source	CREE or OSRAM			
LED QTY(PCS)	18Pcs			
Dimension(mm)	Ø120 x H71			
LED power(w)	1W			
Rate of power(w)	4.5w			
Range of voltage(v/Hz)	DC24V			
Beam Angle	120°			
Color temperature/K	3000K	4000K	5000K	6500
	√	√	√	√
	2200K	2700K	RGB-FULL	DMX
	√	√	√	√
CRI (Ra>)	Ra≥80			
Lifespan	> 5000h			
Radiator	Stretched aluminum housing / Electrostatic spraying			
Net weight(g)	0.36KG			
Dimmable	Non-dimmable			
Working environment	-30~50°C/10% ~ 90% R.H			
Ingress Protection	IP66			

Our quality

requirements are better than the value of the product itself. The products sold by Prodigital Technology Corp. have undergone continuous changes in the market, and the quality requirements specifications can better meet the market use .We look forward to your purchase and use.

We can directly help customers to export CNF. After confirming the quantity, We will help the customer to estimate the export and shipping costs according to the customer's needs.



Taiwan trade



YouTube Video

